

PRODUCT NO
SEE TABLE

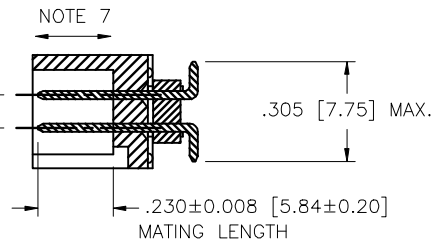

SECTION A-A

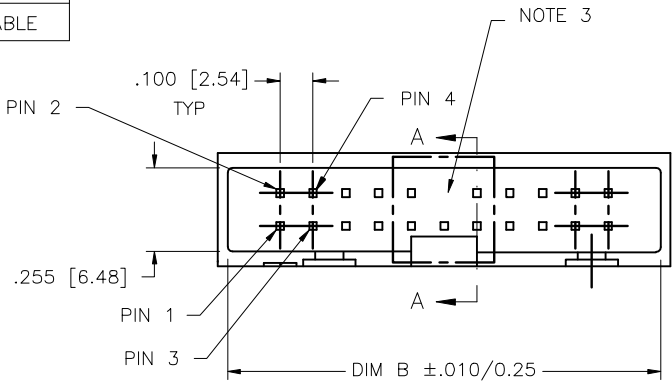
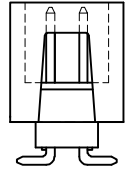
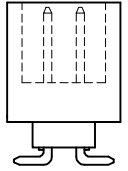
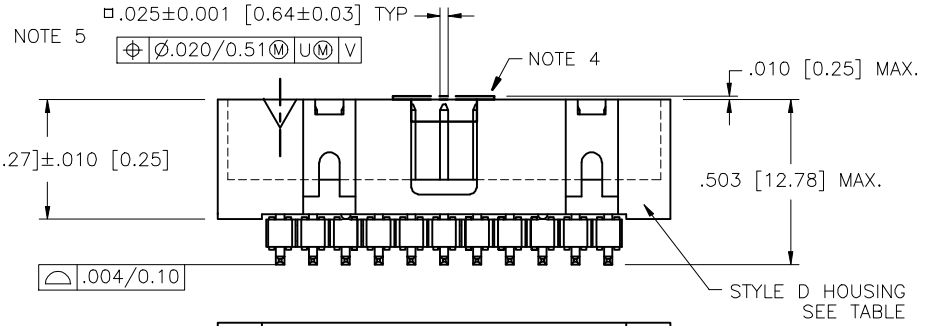

w/WINDOW OPTION
SEE TABLE

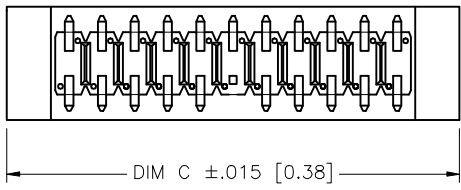

DRAWN WITHOUT WINDOW OPTION

mat'l. code SEE NOTES 1 & 2				surface ISO 1302	tolerance ISO 406 ISO 1101	projection ISO 1302	product family BERGSTIK
ltr	ecn no	dr	date	tolerances unless otherwise specified		INCH/MM	title BERGSTIK® II HDR. D/R SLIMLINE SMT ASSEMBLY
Y	v03-0476	DAI	6/17/03	angles	.XX±.01/XX±0.3		
AA	M05-0086	ERE	9/28/05	linear	.XXX±.006/XXX±0.13	scale 1:1	dwg no 72454
AB	M06-0269	MNR	7/17/06	0'±2'	.XXX±.0020/XXX±0.051		sheet 1 of 4 size A3
AC	M06-0356	MNR	9/08/06	dr	E. KROPWIENICK	8/21/96	type Product Customer Drawing
AD	M08-0108	MHT	4/17/08	engr	L. FYE	8/21/96	
AE	M08-0230	MHT	8/14/08	chr	T. BREWBAKER	8/21/96	
AF	M08-0291	MHT	10/08/08	appd	T. BREWBAKER	8/21/96	
sheet index	revision	AF	AF	AF	AF		
	sheet	1	2	3	4		

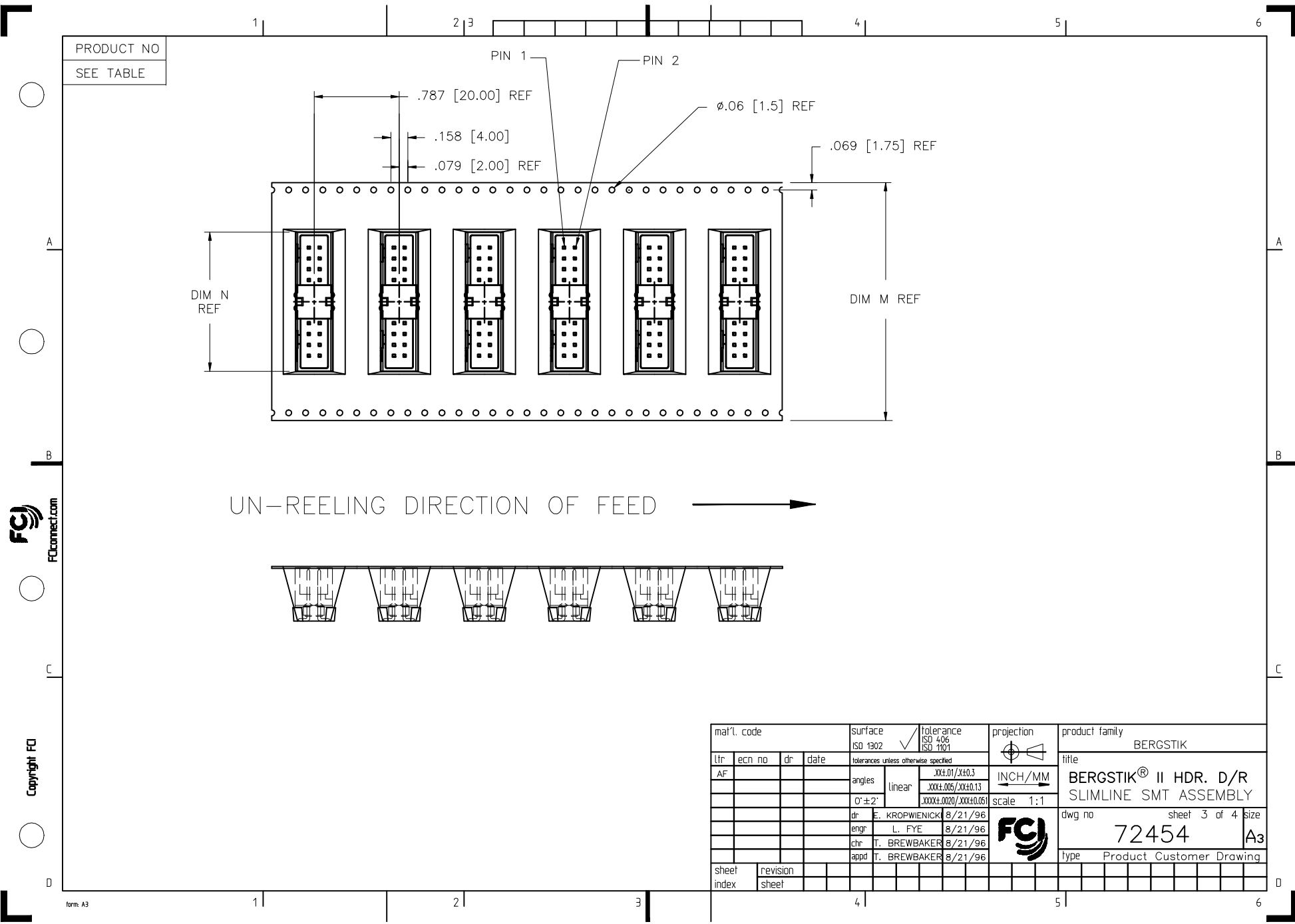

PRODUCT NO
SEE TABLE

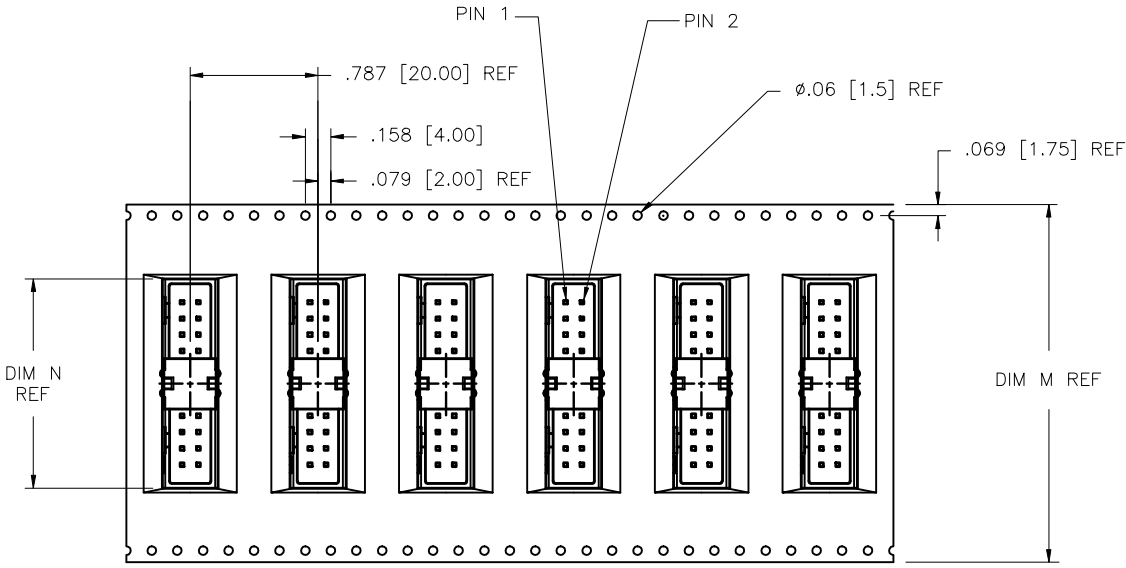

UN-REELING DIRECTION OF FEED →

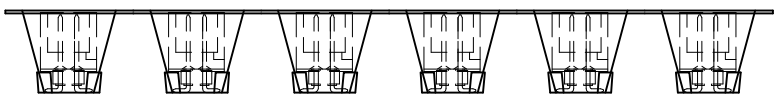

Copyright FCJ

mat'l. code		surface ISO 1302	tolerance ISO 406 ISO 1101	projection 	product family BERGSTIK
ltr	ec'n no	dr	date	tolerances unless otherwise specified	title
AF				linear XXX±.01/XX±0.3 XXX±.006/XX±0.13 XXX±.0020/XXX±0.051	BERGSTIK® II HDR. D/R SLIMLINE SMT ASSEMBLY
				angles 0°±2'	INCH/MM scale 1:1
				dr	dwg no
				engr	sheet 3 of 4 size
				chr	72454 A3
				appd	type
					Product Customer Drawing
sheet	revision				
index	sheet				

PRODUCT NUMBER	NO. OF POSITIONS	DIM B	DIM C	STYLE	POLARIZED POSITION	WINDOW OPTION	PLATING CODE	PACKAGING	TAPE WIDTH DIM M	POCKET DEPTH	DIM N	LEAD FREE OPTION
72454-008	2 X 4	.610/15.50	.690/15.33	A	-	N	AA	TRAY	---	---	---	NOTE 8,9
72454-010	2 X 5	.710/18.03	.790/20.07	A	-	N	AA	TRAY	---	---	---	
72454-010V	2 X 5	.710/18.03	.790/20.07	A	-	N	AA	TAPE ON REEL	1.260/32.00	.515/13.08	.790/20.07	
72454-014	2 X 7	.910/23.11	.99/25.2	D	-	N	AA	TRAY	---	---	---	
72454-014V	2 X 7	.910/23.11	.99/25.2	D	-	N	AA	TAPE ON REEL	1.732/44.00	.515/13.08	1.090/27.69	
72454-016	2 X 8	1.010/25.65	1.090/27.69	D	-	N	AA	TRAY	---	---	---	
72454-016V	2 X 8	1.010/25.65	1.090/27.69	D	-	N	AA	TAPE ON REEL	1.732/44.00	.515/13.08	1.090/27.69	
72454-020	2 X 10	1.210/30.73	1.290/32.77	D	-	N	AA	TRAY	---	---	---	
72454-020V	2 X 10	1.210/30.73	1.290/32.77	D	-	N	AA	TAPE-ON-REEL	2.205/56.00	.505/12.83	1.290/32.77	
72454-021	2 X 11	1.310/33.27	1.390/35.31	D	12	N	AA	TRAY	---	---	---	
72454-022	2 X 11	1.310/33.27	1.390/35.31	D	-	N	AA	TRAY	---	---	---	
72454-024	2 X 12	1.410/35.81	1.490/37.9	D	-	N	AA	---	---	---	---	
72454-024V	2 X 12	1.410/35.81	1.490/37.9	D	-	N	AA	TAPE-ON-REEL	2.205/56.00	.515/13.08	1.490/37.85	
72454-026	2 X 13	1.510/38.35	1.590/40.39	D	-	N	AA	TRAY	---	---	---	
72454-030	2 X 15	1.710/43.43	1.790/45.47	D	-	N	AA	TRAY	---	---	---	
72454-030V	2 X 15	1.710/43.43	1.790/45.47	D	-	N	AA	TAPE-ON-REEL	0.787/20.00	2.834/72.00	1.771/45.00	
72454-034	2 X 17	1.910/48.51	1.990/50.60	D	-	N	AA	TRAY	---	---	---	
72454-040	2 X 20	2.210/56.13	2.290/58.17	D	-	N	4	TRAY	---	---	---	
72454-041	2 X 20	2.210/56.13	2.290/58.17	D	-	N	AA	TRAY	---	---	---	
72454-044	2 X 22	2.410/61.21	2.490/63.25	D	-	N	AA	TRAY	---	---	---	
72454-050	2 X 25	2.710/68.83	2.790/70.87	D	-	N	AA	TRAY	---	---	---	
72454-051	2 X 10	1.210/30.73	1.290/32.77	D	-	Y	AA	TRAY	---	---	---	
72454-051V	2 X 10	1.210/30.73	1.290/32.77	D	-	Y	AA	TAPE-ON-REEL	2.205/56.00	.505/12.83	1.290/32.77	
72454-052	2 X 20	2.210/56.13	2.290/58.17	D	20	N	AA	TRAY	---	---	---	
72454-053V	2 X 5	0.710/18.03	0.790/20.07	A	9	N	AA	TAPE ON REEL	1.260/32.00	.515/13.08	.790/20.07	



Copyright FCJ

mat'l. code		surface	tolerance	projection	product family
ISO 1902		ISO 406	ISO 1101		BERGSTIK
ltr	ecn no	dr	date	title	
AF				BERGSTIK® II HDR. D/R	
angles		linear	linear	INCH/MM	SLIMLINE SMT ASSEMBLY
0°±2'		XXX±.01/XX±0.3	XXX±.006/XX±0.13	scale 1:1	
dr	E. KROPWIENICK	8/21/96		dwg no	sheet 4 of 4 size
engr	L. FYE	8/21/96		72454	A3
chr	T. BREWBAKER	8/21/96		type Product Customer Drawing	
appd	T. BREWBAKER	8/21/96			
sheet index	revision sheet				